

MOVACOLOR

C O L O R I N C O N T R O L

MC-12

User Manual 1.05.UK.01

Software version : V1.05
Manual revision : 01
Date : September 2009









Movacolor B.V • Koperslagersstraat 31 • 8601 WL Sneek • The Netherlands

Internet: www.movacolor.com • Email: info@movacolor.com

 + 31 (0) 515 570020

 + 31 (0) 515 570021

INDEX

INDEX	2
1. Introduction	3
<i>Symbols:</i>	3
<i>Terms:</i>	3
2. General information	4
2.1 <i>Safety</i>	4
2.2 <i>Certification</i>	4
2.3 <i>Operating environmental conditions</i>	4
3. Overview Dosing unit	5
3.1 <i>MC-12 Components overview.</i>	5
3.2 <i>Motor and dosing system.</i>	5
3.3 <i>Neckpiece</i>	6
4. Metering principle	7
5. Dosing systems / Capacities	8
6. Installation	10
6.1 <i>Transport</i>	10
6.2 <i>Receipt</i>	10
6.3 <i>Mechanical Installation</i>	10
6.4 <i>Changing from Dosing cylinder to Feed screw</i>	11
6.5 <i>Electrical Connections</i>	12
7. Operation	13
7.1 <i>The Interface</i>	13
7.2 <i>General</i>	13
7.3 <i>Start up</i>	14
7.4 <i>Configuration</i>	14
7.5 <i>Speed  and Timer </i>	14
7.6 <i>Production (Motor On/Off)  </i>	15
7.7 <i>Test  (Material output), can only be used when unit is stopped </i>	15
7.8 <i>Alarms / Warnings</i>	15
7.9 <i>Keyboard lock</i>	15
8. System performance	16
APPENDIX A: MC-12 Wiring Diagram	17
APPENDIX B: MC-12 Technical Specifications	18
APPENDIX C: MC-12 General dimensions	19
APPENDIX D: MC-12 Declaration of Conformity	20

1. Introduction

Thank you for purchasing a Movacolor metering device. This manual is addressed to operators and **qualified technicians** taking care of the metering of dry additives to ensure correct use of the Movacolor dosing unit.

① **IMPORTANT NOTE: THIS MANUAL MUST BE READ BEFORE INSTALLING THE DOSING UNIT. KEEP THIS MANUAL IN A PLACE ACCESSIBLE TO ALL OPERATORS.**

Symbols:

① Important note



Attention; safety regulations for the operator

Terms:

Operator: A person charged to operate, adjust, maintain and clean the machine.

Qualified Technician: A specialized, suitable trained person authorized to execute the installation, non-routine maintenance, or repairs requiring special knowledge of the machine and how it operates.

2. General information

2.1 Safety



The equipment is only designed and may only be used, for the dosing of dry additives. Any use that does not conform to the instructions is considered improper and as such releases the manufacturer from any liability in regard to damage to things and/or persons.



Always switch off the Movacolor control cabinet and disconnect from electrical power before performing maintenance.



Ensure that all parts are securely fixed to the extruder or injection molding machine.



Dangerous voltages are present inside the control cabinet for up to 2 minutes after it has been switched off.

2.2 Certification

- The Movacolor dosing unit is designed and produced conform the following European regulations:
- C€ standards for machinery (health, safety, environment)
- EMC (electromagnetic compatibility)
- VEM (safety electric material)
- 98/37/EC, Annex 1 (See the declaration of conformity, Appendix C)

2.3 Operating environmental conditions

- The unit must be protected against weather conditions
- Operating temperature -20 to +70 degr. C.

3. Overview Dosing unit

3.1 MC-12 Components overview.

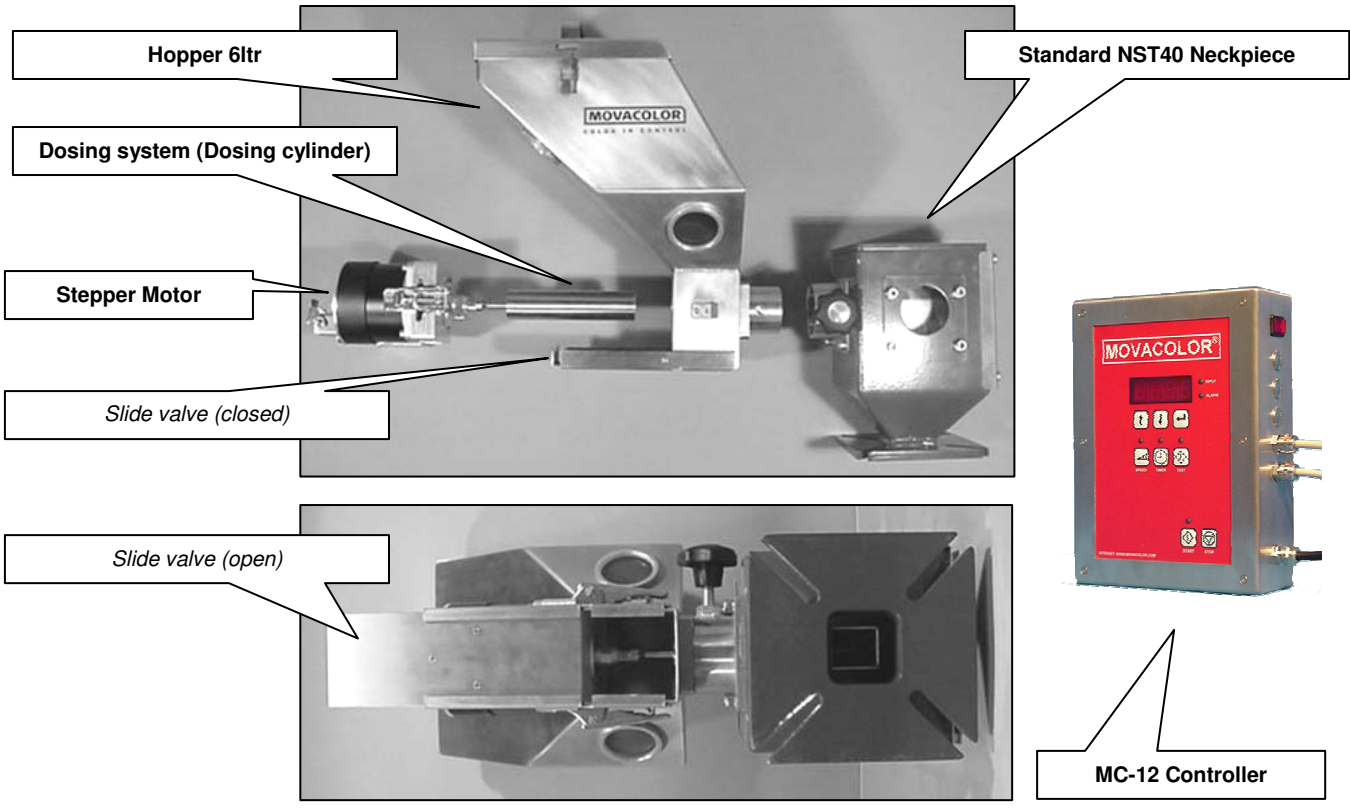

3.2 Motor and dosing system.

There are mainly two dosing systems, the dosing cylinder and the feed screw.
(for more information see chapter 5)

The serial number of the motor can be found on the backside of the motor.

Motor axle:
The motor shaft is equipped with one flat side which fits exact in shaft of the dosing cylinder.
To connect the dosing cylinder just put it on the motor axle while turning it to find the flat side, than press the dosing cylinder completely backwards.

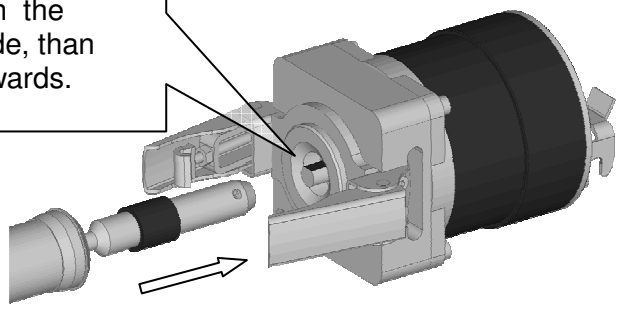

3.3 Neckpiece

The NST40-Neckpiece is the standard neckpiece for the MC-12 . The window of the NST40 neckpiece can be dismantled for easy cleaning. Together with the window the insert is taken out.

Easy cleaning

Dismount only these 4 bolts.

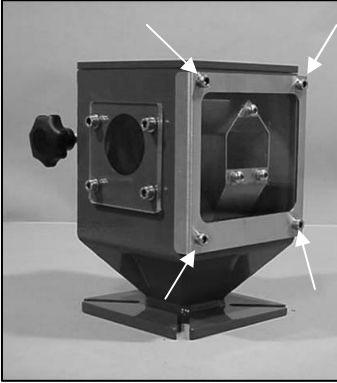

Take out the window in a 45° angle.

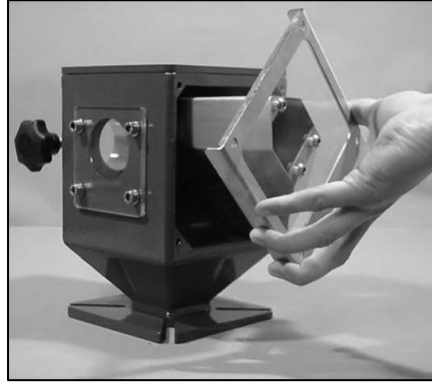

4. Metering principle

The Dosing Cylinder® of Movacolor combined with a very precise adjustable stepping motor ensures that the additive output is accurate and regular. For every particular application Movacolor provides different neckpieces but the most common mounting of the neckpiece is between the production machine and the hopper. In the figure below a cut through of the NST40 neckpiece can be seen.

During operation, the virgin material runs from the machine hopper through the neckpiece (1) into the machine. Inside the neckpiece the virgin material flow (4) is divided into two streams by the cover plate(3). In the space below the cover plate, the rotating cylinder (2) is dosing additive.

Additive is added directly into the center of the virgin material flow, just before it enters the production machine (5). This is a great advantage over metering devices that use batch pre-mixing because pre-mixing can actually cause material separation. Separation of materials results in an irregular additive flow into the production machine.

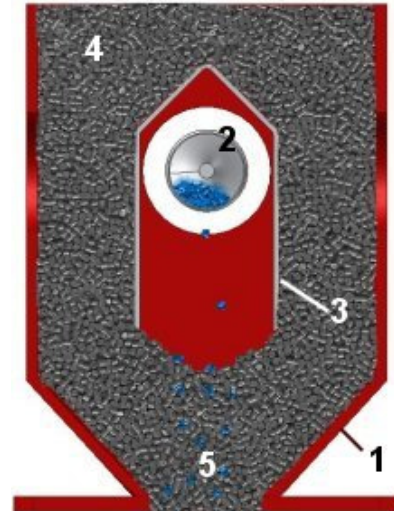

Fig. 3

- 1. Neckpiece 2. Dosing cylinder 3. Cover plate
- 4. Virgin material 5. To production machine

5. Dosing systems / Capacities

Depending on the application a different dosing system might be needed. Use the following table to determine roughly the best system for the application. For more detailed information please contact your agent or Movacolor.

Dosing system	Granular materials	Powder Materials	Accuracy	Dosing capacity Gram/sec.	Dosing capacity Kg/hour
GLX	YES	YES	++	0,02 to 1,6*	0,07 to 5,8*
GX	YES	YES	+	0,2 to 5,0*	0,72 to 18,0*
HX	NO	YES	++	0,01 to 1,6**	0,04 to 5,8**
A-20 Feed screw	YES	YES	+/-	0,5 to 20*	1,8 to 72*

Note * measured with normal granular masterbatch 0,8 kg/dm³.

Note ** measured with free flowing powder 0,65 kg/dm³.

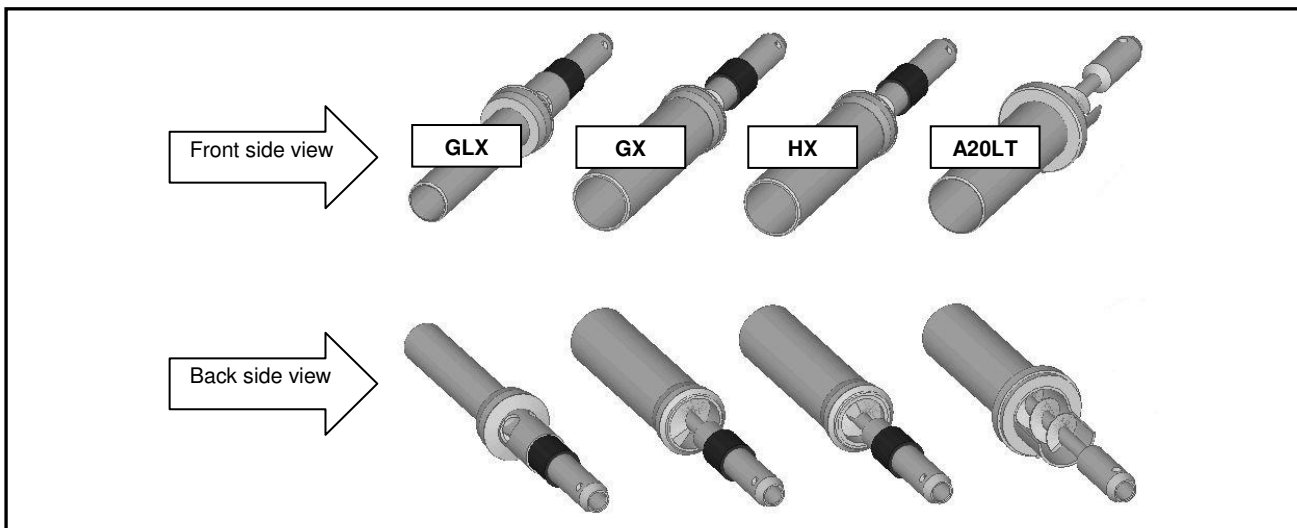

Which type of dosing system do I need with which neckpiece?

TYPE	CODE FOR STANDARD NECKPIECE	CODE FOR WATERCOOLED NECKPIECE
GLX	GLX	GLXC
GX	GX	GXC
HX	HX	HXC
A20LT	A20	A20C

To determine the kind of material in your application use the description below.

Material types

**Normal Granules:
(NG)**

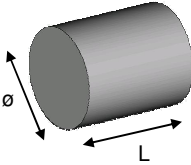

$\varnothing < 4 \text{ mm}$ $L < 4 \text{ mm}^*$

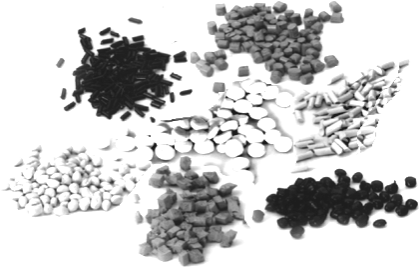

**Micro / Mini Granules:
(MG)**

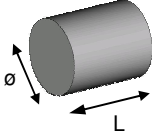

The term Micro/Mini Granules also includes free flowing powder. $\varnothing < \varnothing 2,5 \text{ mm}$ $L < 3 \text{ mm}^*$



* For other sizes contact Movacolor.

The actual capacity of the dosing system depends on:

- The volume weight of the material (*bulk density*)
- The specific weight of the material (*specific density*)
- The granular shape of the material
- The granule size
- The surface structure of the material

Granular material can be normal or micro. The granular material and powder material has to be free flowing, non-static and not sticky.

6. Installation

6.1 Transport

To protect the Movacolor unit against damage during transport, the unit is packed in a cardboard box filled with polyurethane foam. In the event of damage to the unit, please contact your local agent or Movacolor immediately. Delivery terms are Ex-Works Sneek, The Netherlands. Buyer is responsible for the transport. Movacolor cannot be held liable for any damage during transport.

6.2 Receipt

Check the unit thoroughly upon receipt. Pass any remarks to the local agent or Movacolor within 8 days upon receipt of goods.

6.3 Mechanical Installation

1. All mechanical parts are pre-assembled, making installation quick and simple.
2. Install the neckpiece directly on top of the entrance of the production machine.
 - a. Make sure that the complete unit is mounted horizontally leveled and fixed securely.
 - b. Assure proper grounding to control cabinet, neckpiece and dosing unit
3. Connect the unit to the neckpiece by closing curled knob clockwise.



Mount the unit in a 90-degree angle to the machine barrel.

As shown in the picture.

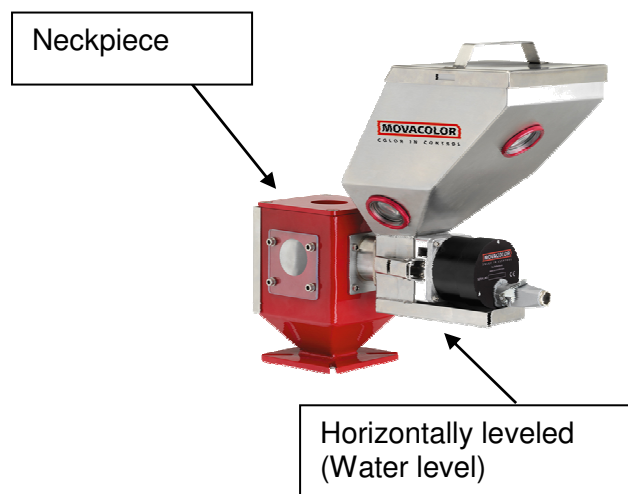

6.4 Changing from Dosing cylinder to Feed screw

In relation to the maximum capacity of the dosing cylinder it might be necessary to change from dosing cylinder to feed screw. As distinction from the dosing cylinder the feed screw system is consisting of a rotating screw in a **non**-rotating tube.

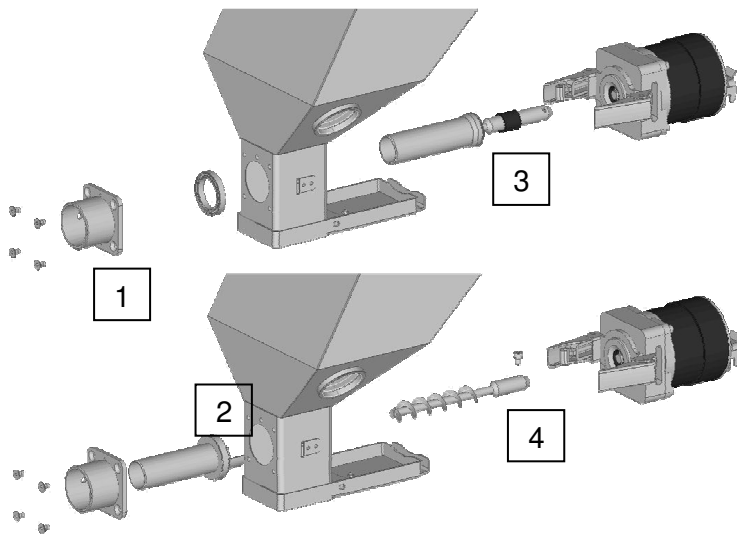

To install the feed screw perform to following steps:

1. Detach the motor quick release clamps and take out the motor from the hopper.
 2. Dismount the neckpiece connection flange (1) by removing 4 socket-head screws.
 3. For use with a dosing cylinder the neckpiece connection flange (1) is equipped with a ball bearing. When using a feed screw system the ball bearing must be taken out. The metal ring (2) which is fixed on the feed screw tube fits directly on the neckpiece connection flange.
 4. Dismount the dosing cylinder (3) and mount the screw (4) with the M5 bolt.
 5. Place back the motor + screw by closing the motor quick release clamps.
- For cleaning the motor + screw can be easily be taken out.

POSSIBLE COMBINATIONS

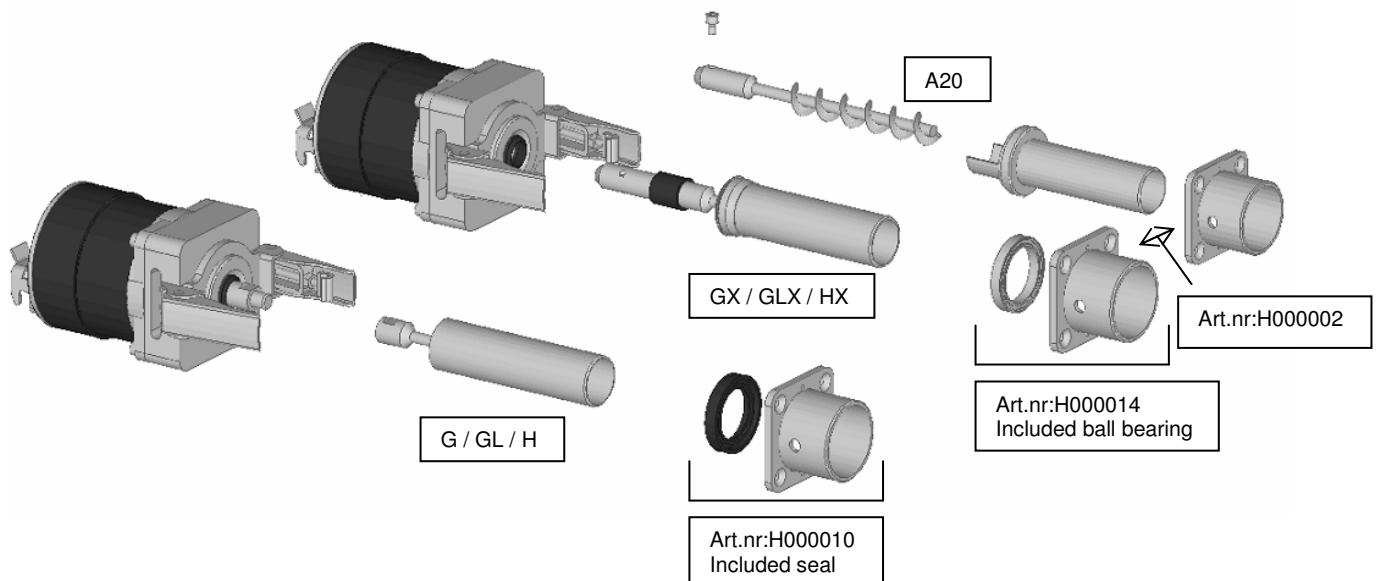

BALL BEARING

- ① For cleaning of the ball bearing use a dry piece of textile or a smooth dry toothbrush to remove the dust or moisture and foreign particles that stick.
- ① Following points have effect on the lifetime of the ball bearing:
 - Abrasive materials / Temperature / Dusty / fine powder materials

6.5 Electrical Connections

The MC-12 needs an input signal from the production machine in order to operate.

Two different input signals can be used to control the MC-12.

1. **A potential free relay contact.**
Use the white and brown wire for the potential free contact.
2. **A relay signal up to 24 Volt DC.**
Relay signals can be used for an extruder that has not a tacho signal. In case of a powered relay signal connect the white wire to +24 VDC and the yellow wire to - side.

See **APPENDIX A** for the wiring diagram.

7. Operation

7.1 The Interface

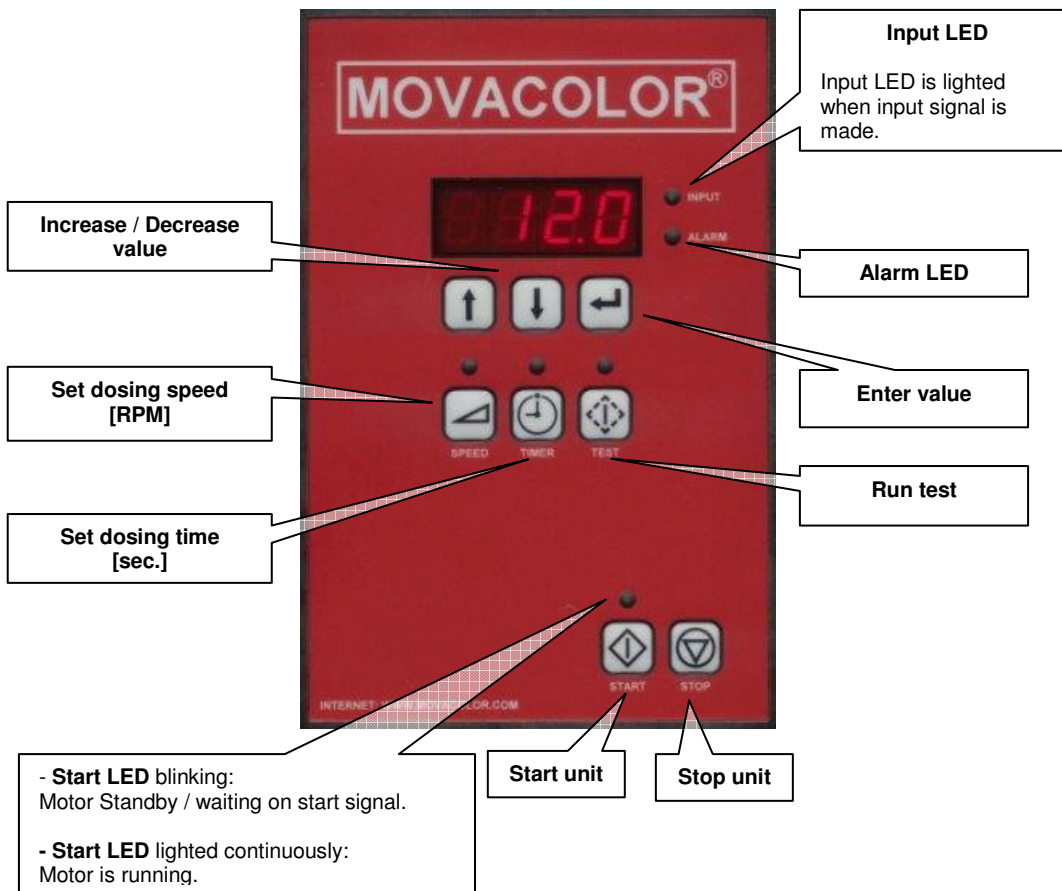

7.2 General

- Connect motor before switching on the controller
- ALL changes \uparrow \downarrow has to be entered \leftarrow to acknowledge.
- A blinking value means the changed data is not entered.
- To cancel a changed value, press the specific function button (\leftarrow or \odot) again.
- Most functions have a designated key and LED on the interface. When a function is activated the LED of that key/function will light up.
- All functions except the test \odot function can be activated if the unit is started, (dependent on the chosen configuration.)
- Only one of the following functions \leftarrow , \odot , can be active at the same time. This means no other function can be activated before the active function is deactivated

ⓘ The unit can be set to different configurations, see paragraph 7.4

7.3 Start up

The MC-12 software version is displayed shortly when the unit is switched on followed by the configuration mode (con).



Configuration	Type of Production	Input signal
1	Injection Molding	Timer
2	Extrusion	Relay



When the MC-12 is set to configuration 2, the time function key  is deactivated.

When a deactivated key is pushed the unit will give a beeping signal.

For changing the unit configuration see paragraph 7.4.

7.4 Configuration

To make the configuration available, keep speed  and enter  pressed while switching on the main power.

The configuration number will be displayed, press   to switch between the possible configuration and press  to acknowledge. The software version will be displayed.

Timer

Timer mode is used for injection molding with a relay input signal. When the relay contact is made, the unit will start dosing according to the number of seconds that has been set with the time function.

Relay





A relay signal can be used in case of working in extruder mode. With the relay input the unit will start dosing when the relay contact is made and will stop when the relay is interrupted.

7.5 Speed and Timer

Speed and dosing time can be altered (time only in case of injection molding)

Speed  = rotation of dosing system in RPM, (0,1 to 200 RPM)

Timer  = time dosing system will rotate after start impulse, at input cable (0,1 to 999,9 sec)



Activate by pressing  or  , set the desired speed or time using   press enter  to acknowledge

7.6 Production (Motor On/Off)

Press  to start production. The function active LED will start blinking when the unit is waiting for an input signal. The unit is dosing if the Start LED is lighted continuously.

7.7 Test (Material output), can only be used when unit is stopped

Test procedure to determine output of dosing system:
Place dosing unit horizontally leveled (water level surface).

- Set the speed (and or) time (see settings)
- Press  for Test
- Weigh the material dosed during test
- Adjust speed or time and repeat  Test if necessary.

Note:

(Configuration 1): The unit will dose with the set speed and time.

(Configuration 2): The unit will dose for 30 seconds at the set speed

 Emergency stop.

If the test is activated press stop  to cancel a test.

7.8 Alarms / Warnings



Err0 : Motor connection failure.

Make sure the motor is connected

Check cable and connectors

Press  to stop the alarm.

7.9 Keyboard lock

 +  +  = Lock / Unlock,

Display shows : L.ON / L.OFF

8. System performance

The following variables may influence the accuracy and repeatability of the system:

1. Material properties. Easy flowing, non-sticky and non-static material that comes in the form of small regular shaped granules or powder can be dosed very accurate and regular.
2. Periodical cleaning of the dosing cylinder and seals is necessary for proper operation.
3. Extreme vibrations and shocks can have negative influence on system performance.
4. An unstable relay signal has a negative influence on the repeatability.
5. With injection molding the shot to shot accuracy depends, besides the variables mentioned so far, on the shot time in combination with granule size and weight. If relatively big and heavy granules have to be dosed in a very short time, it will influence the shot accuracy and repeatability, because if only a few granules are dosed during the shot, one granule more or less makes a big difference on the total shot weight.
6. Vacuum or overpressure in the neckpiece caused by driers or hopper loaders.
7. Bridging or rat holing of the material inside the hopper can happen if the material is not free flowing.
8. Bridging or rat holing of the material inside the hopper can happen if the material is extremely static.
9. Extremely static material can contaminate the dosing cylinder.
10. In case of water cooled neckpiece, check if there is material build up around the dosing cylinder and the water cooled pipe. Check also the water supply to the neckpiece.

APPENDIX A: MC-12 Wiring Diagram

Input (start) signal

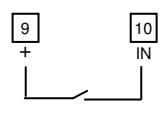

Potential free contact

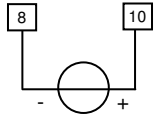

Potential contact
[Min 18VDC to Max.24VDC]

- 8 = Yellow
- 9 = Brown
- 10 = White

Motor

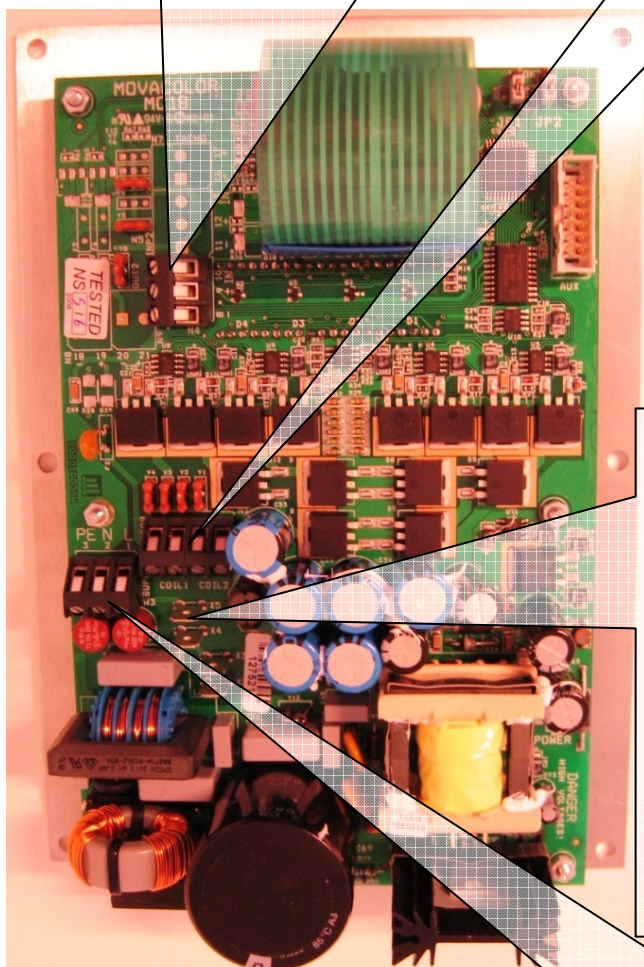
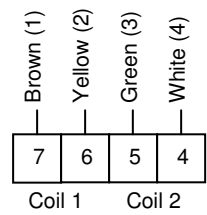

Internal wires Main power switch

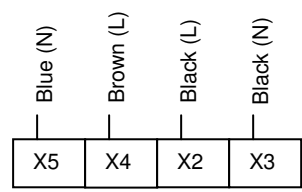

① To open the control cabinet use the 4 bolts on the top and bottom side, not the 6 bolts at the front side.

① **WARNING**
Do not make any adaptation to the main board/components ore warranty will lapse.

Power Supply

Western Europe

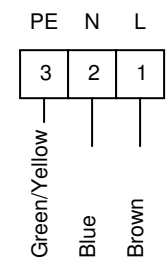

USA,Canada,Mexico, Mid America,Japan,Taiwan

- 1 = Black
- 2 = White
- 3 = Green

APPENDIX B: MC-12 Technical Specifications

Controls:

Speed: Manual setting from 0,1 to 200 RPM max, in increments of 0.1 RPM.
Time: Manual settings from 0,1 to 999,9 sec in increments of 0,1 sec.

Monitoring/System Information/External communication

4-piece 7 segments LED at front display.
Man/Machine interface: keypad
External Communication: none
Alarm: LED Indication + Internal beeper.

Specifications/Standards & Directives/ Technical data:

Power supply: Operating power from 80 VAC to 260 VAC, 50 and 60 Hz
by integrated automatic voltage selector
Power consumption: 80 Watt maximum
Stepper motor: (1,8degr/step) max 2 Amp at 40 Volt.
Operating Temperature: -20 to +70 degr. C.

Input signal(s):

Injection molding: Start/Stop trigger input, potential free or 18-24VDC*
Extrusion: Start/Stop trigger input, potential free or 18-24VDC*

* Note potential contact

Guaranteed OFF: 0-8VDC
Guaranteed ON: 18-30VDC

Output(s):

Stepper motor max. output 2A (40VDC)

Standard Directives:

Protection class: IP-50
According to CE standards:
EN50081-2 (HF radiation industry)
EN50082-2 (HF immunity industry)

Safety

- In case of overload due to short-circuit or in correct connection, the power supply automatically shuts down.
- Opto insulated start input for connection to production machine.

Machine connection flange:

Standard flange NST40 neckpiece with cleaning opening.
Inlet/outlet \varnothing 50mm/ \square 40mm, steel epoxy coated

Optional parts

- 12 liter hopper stainless steel.
- Flange type NST90 with cleaning opening and inlet/outlet \varnothing 50mm/ \square 90mm, steel epoxy coated.
- Water-cooled flange BH(A) inlet/outlet 50mm/50mm stainless steel ANSI 304.
- Water-cooled flange PHA inlet/outlet 100mm/100mm

(See next page for technical drawing.)

APPENDIX C: MC-12 General dimensions

General dimensions MC-12 + NST40 neckpiece

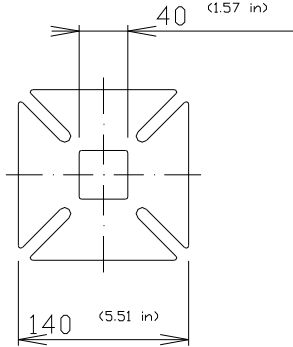
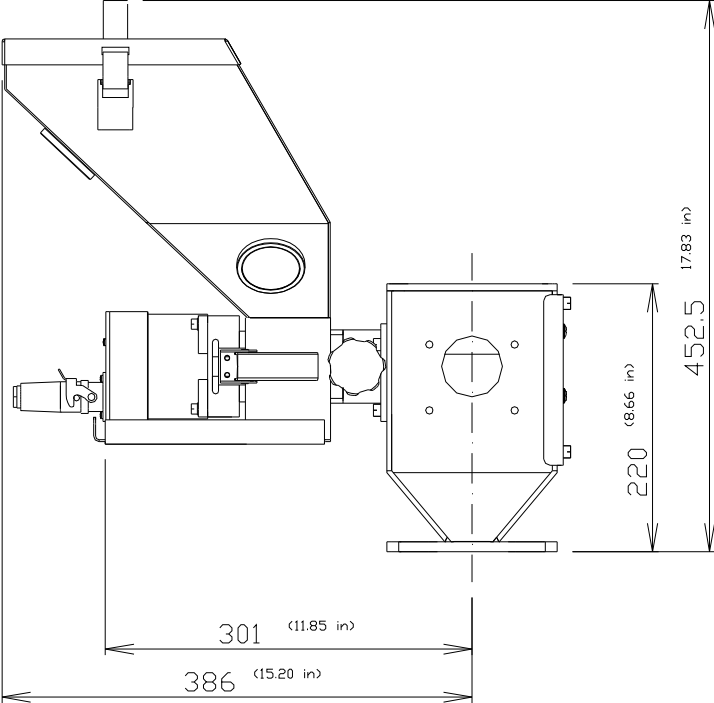

BOTTOM FLANGE

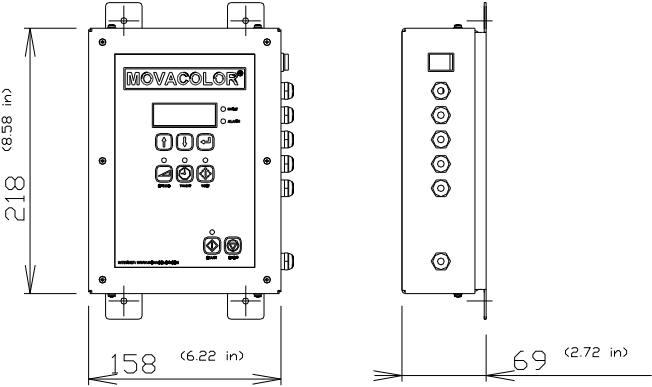

CONTROL CABINET

APPENDIX D: MC-12 Declaration of Conformity

DECLARATION OF CONFORMITY

(According to 98/37/EC, Annex 1)

Manufacturer's name : **MOVACOLOR BV**
Address : **P.O. Box 3016**
8600 DA Sneek
The Netherlands

Declare under our sole responsibility that the product:

Name : **Movacolor**
Model : **MC-12**
Year : **200.....**
Serial nr. : **.....**

- **Complies with the definition of the Machine Directive (98/37/EC), and complies with the national legislation to enforcement of this directive;**

- **complies with the requirements of:**
 Low Voltage Directive (73/23/EEC)
 EMC Directive (89/336/EEC)

- **complies with the following standards or other normative documents:**
 NEN-EN 292-1/2 Safety of machinery part 1 + 2

(Signature)



Place: Sneek the Netherlands

Managing Director

Date: September 29, 2009